



Wood Bracket 04T8 is handcrafted of solid Western Red Cedar Timbers. Cedar timbers have unique natural colors, grains, tight knots and textures. All our brackets are built to last, joined with screws or bolts depending on the size of the bracket, we also use a special exterior grade glue at each connection. The bracket is finished with the option you selected and ready for your paint or stain depending on your project requirements. For additional strength you can order our structural bracket, please call our customer support for pricing and ordering information. **Custom Order Available: Size, Wood Species, and/or Design**

Bracket Finish

Product Option

- SMOOTH
- ROUGH SAWN

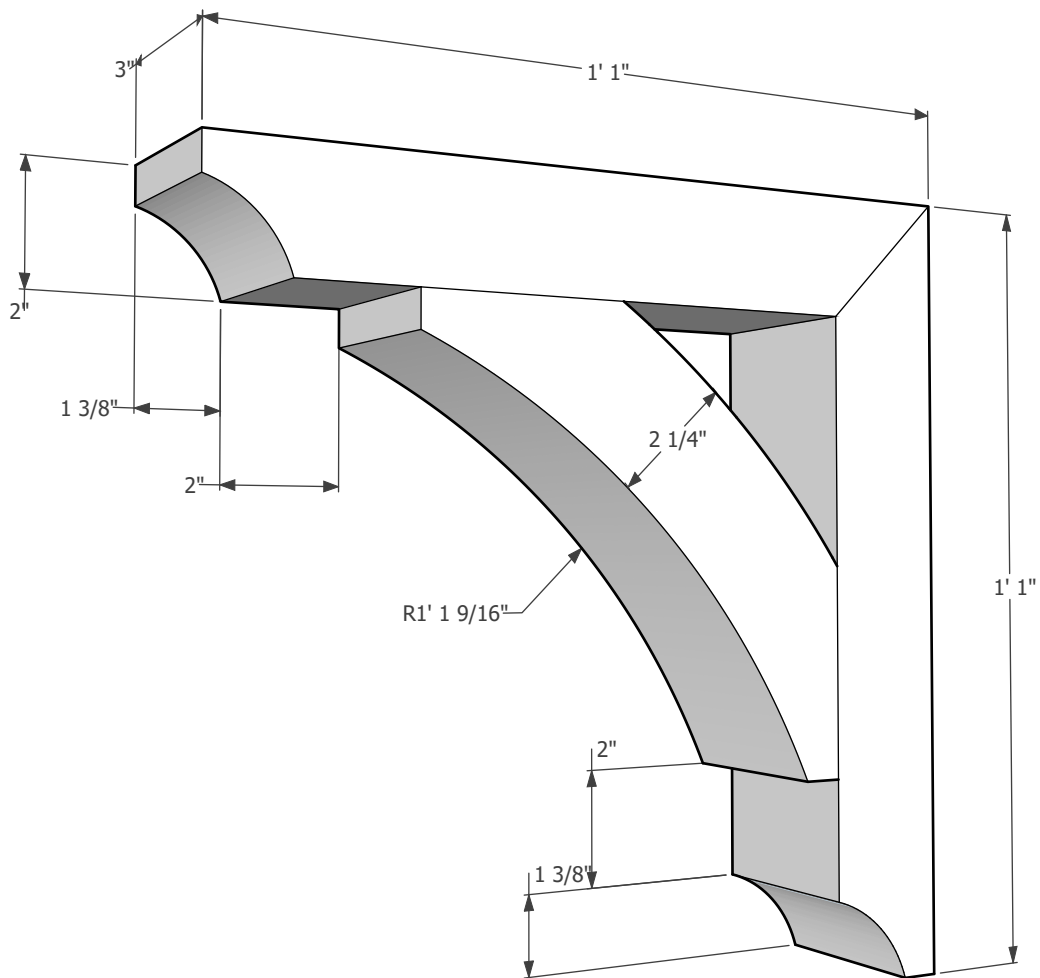

Copyright Statement: All drawings, pictures, and specifications are the property of Timber Build and shall not be reproduced, copied, or used as the basis for manufacture, comparable pricing (bid), or sale of a product without the written permission of Timber Build.

770-406-6646
www.TimberBuild.com
Sales@TimberBuild.com

CAD Drawing Available
www.TimberBuild.com/CAD

Scale: Not To Scale

May 4, 2022

Page

1